

Article number: 201302018

Description: E+G  
Keyring GN 111.3-18

## Measures

---

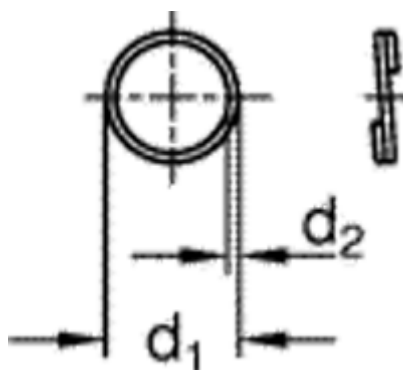

$d_1 = 18$

$d_2 = 1.3$